



PERMAFORM

QUICK ▶ STRONG ▶ STRAIGHT

PRODUCT CATALOGUE AND ORDERING CODES

AS AT FEBRUARY 2021

PANEL (AP)

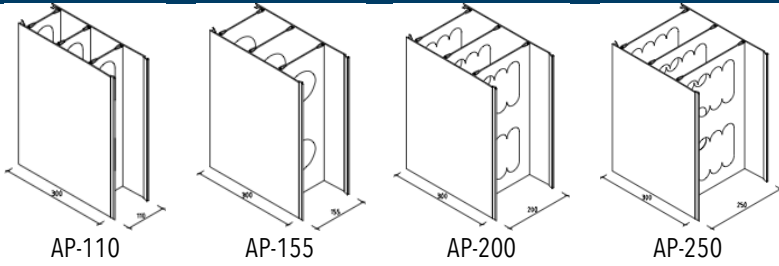

PANEL CONNECTOR (PC)

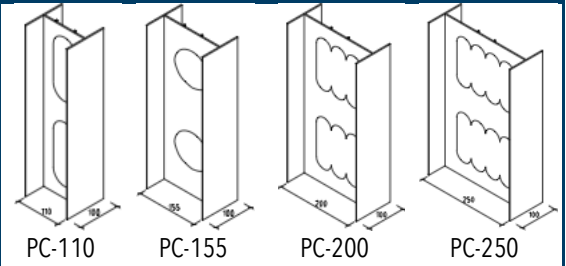

EDGE FLASHING (EF)

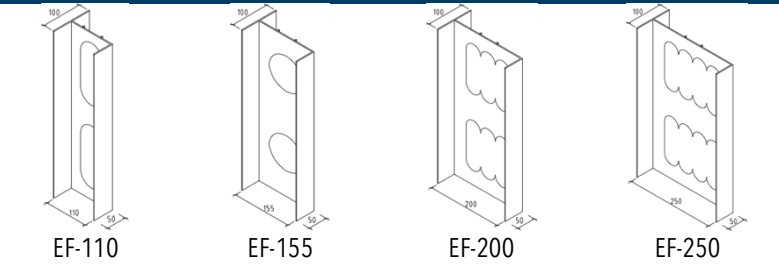

END CAP - MALE (ECM)

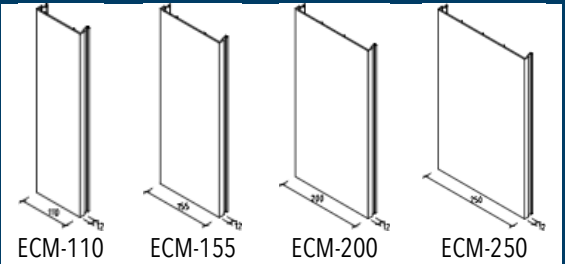

JUNCTION TRACK - FEMALE (JTF)

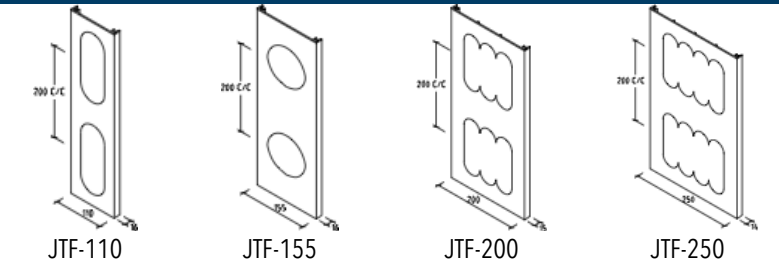

END CAP - FEMALE (ECF)

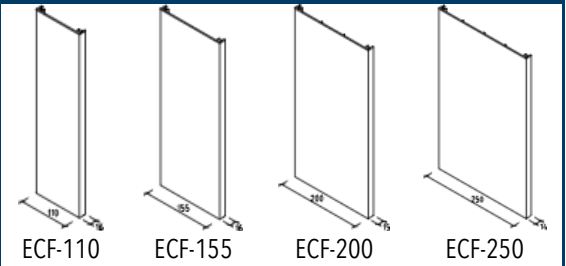

JUNCTION TRACK - MALE (JTM)

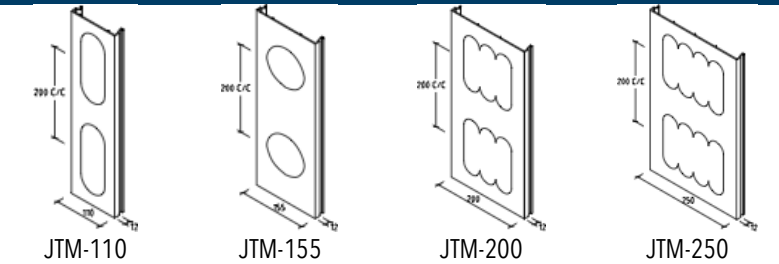

CORNER STOP

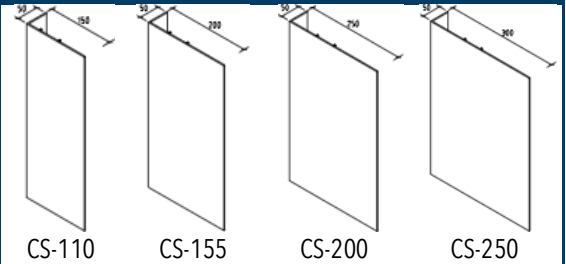

BOTTOM TRACK (BT)

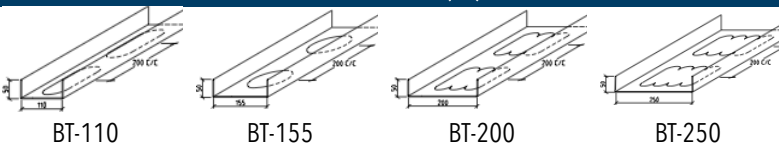

CORNER PANEL (CP)

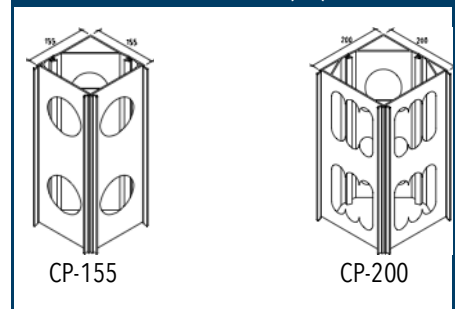

TOP CAP (TC)

